

1.

ME203_08

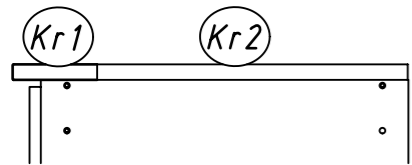

Typ I

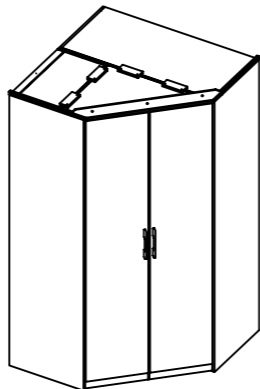
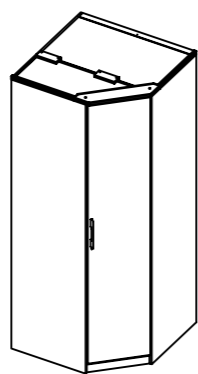
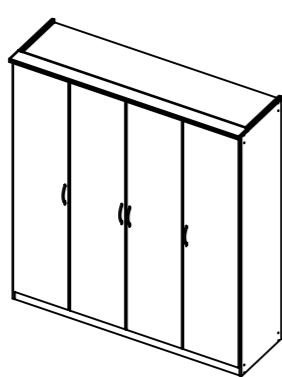

Typ II

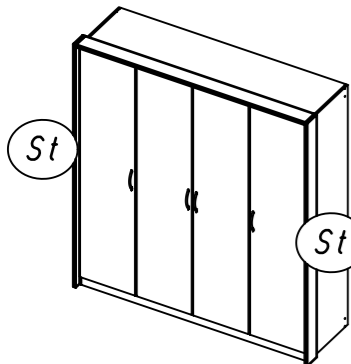
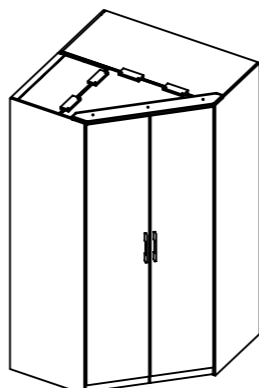
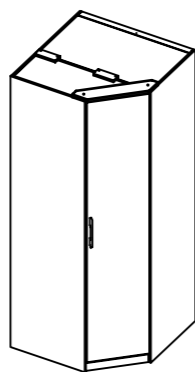
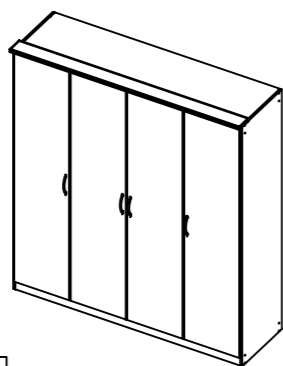

Typ III

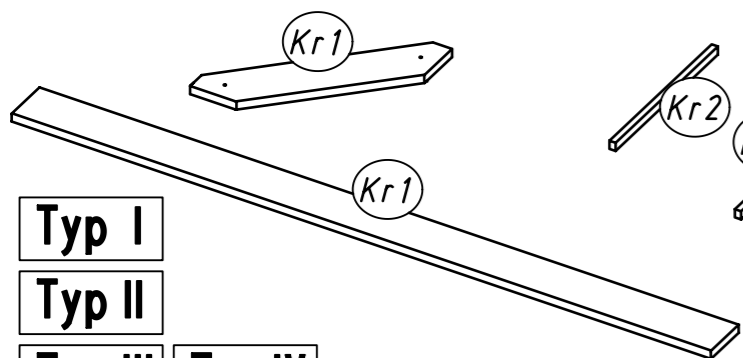

Typ I

Typ II

Typ III Typ IV

Typ I

11

174

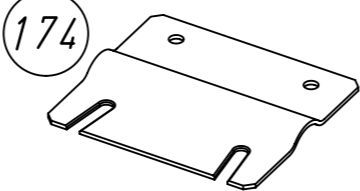
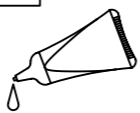
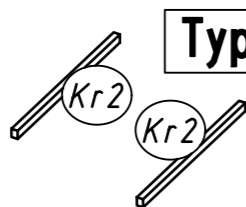

547

4x35

202



4.5x16

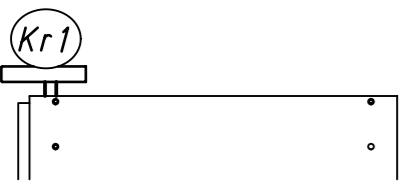

Typ IV

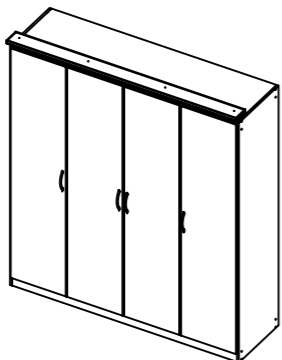

626

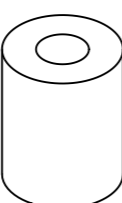

ø16x20

229

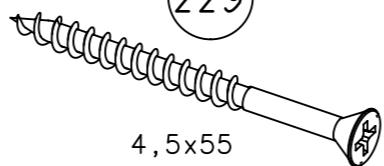

4,5x55

2.

1

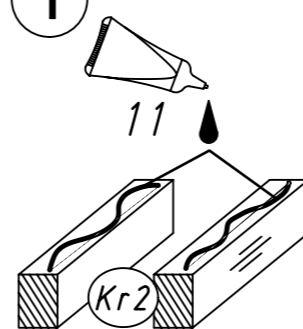

Typ I

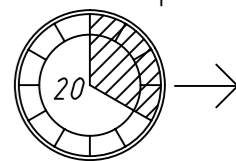
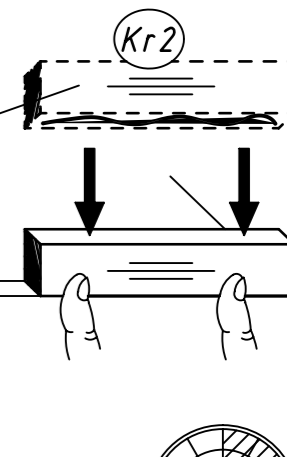
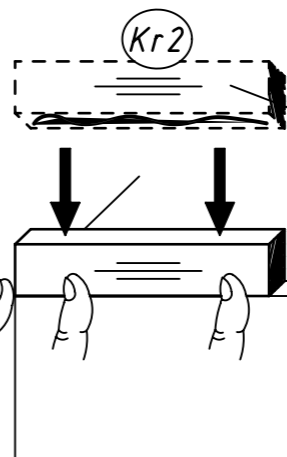

2

547

Typ I Typ II Typ III

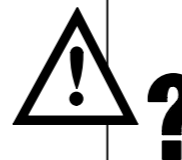
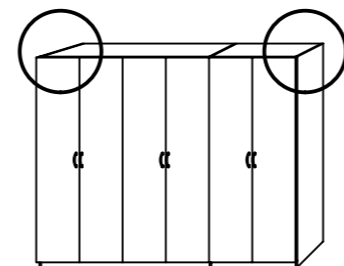

?

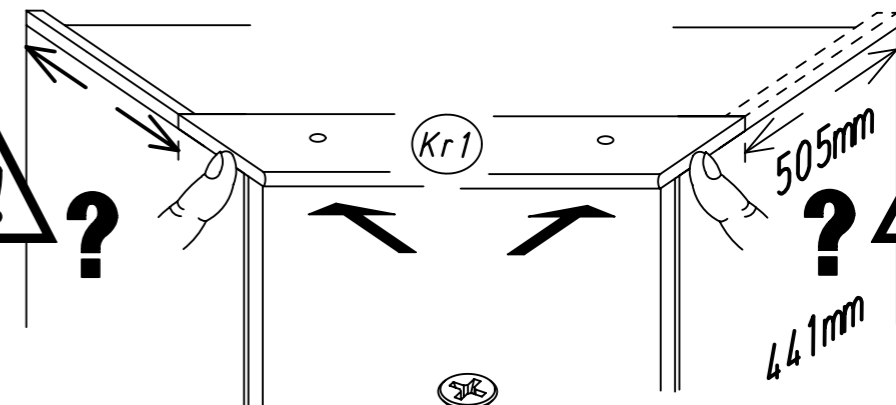

?

